

Sample Pro[®]

Sample Pro[®]

Sample Pro 3/4"
Portable
MicroPurge Pump
USER'S GUIDE

Part No. 95192 4-22-19



Topic	Page
Introduction _____	1
Figure 1/Pump Overview _____	1
Description _____	2
Figure 2 / Main Components _____	3
Assembly _____	4
Figure 3 / O-Ring Replacement _____	4
Attaching Tubing / Disassembly / Cleaning / Decontamination Note _____	5
Figure 4/ Tubing Attachment Tool _____	5
Figure 5 / Using Needlenose Pliers for Check Ball Stop Assembly/Disassembly	6
Figure 6 / Pump Tubing Fitting Assembly _____	7
Figure 7 / Pump Head Assembly _____	8
Bladder Replacement _____	9
Specifications _____	10
QED Service Contacts _____	10
Important Warranty Note _____	10
QED Warranty _____	11

Introduction

Introduction

The Sample Pro 3/4" Portable MicroPurge[®] Pump, (**Figure 1**) is the first pump designed specifically to meet the practical needs of sampling small diameter wells: easy to adjust to low-flow purging rates and easy to decontaminate between sampling points. Decon is made easier by the pump having fewer parts, disassembly without tools, and quick-change, disposable bladders. The Portable MicroPurge Pump is compact and can pump from a 5-gallon bucket. The pump is operated by compressed gas and a bladder pump control unit, and is ideally used with the MicroPurge basics models MP10 and MP15 controllers. The compressed gas is on the outside of the bladder and the pumped liquid is on the inside of the bladder, so there is no contact between the sample and the gas.

Figure 1

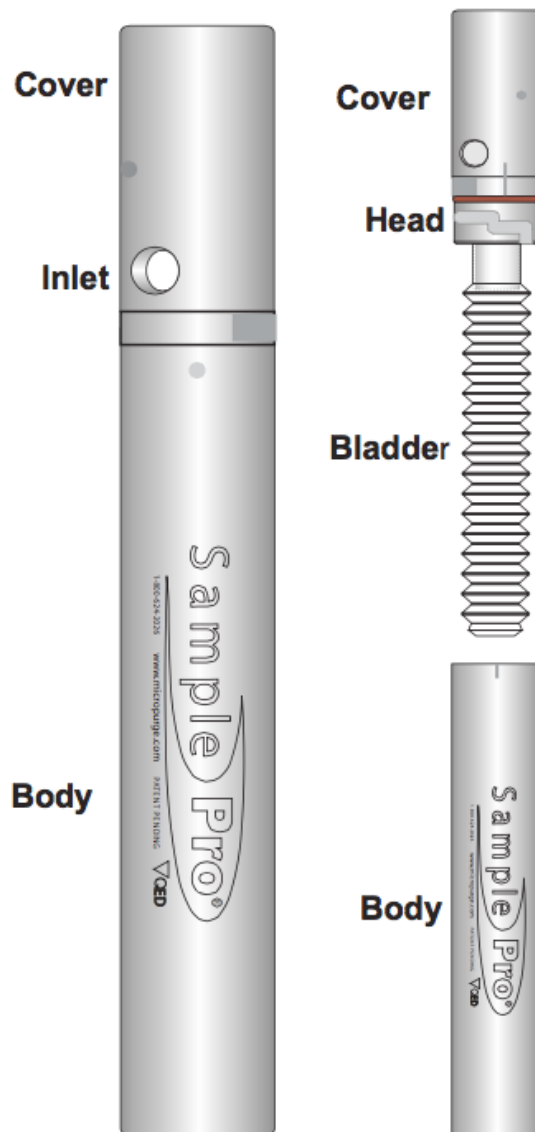

Description

Figure 2 (Page 3) shows the main components of the Portable MicroPurge Pump and the assembled pump. The body twists off for quick change of the disposable polyethylene (PE) bladder . The bladder simply pushes on to provide a leak-tight seal for most applications without the use of clamps.

The cap of the pump twists off for full disassembly of the inlet and outlet check valves and the tubing connection components.

The pump uses 1/8" O.D. tubing for compressed gas supply and 1/4" O.D. tubing for the sample discharge. Tubing connections to the pump are made via push-in fittings built into the top of the pump.

The push-in connections provide excellent pull out strength when used with QED tubing, so that use of a support cable is not required. However a connection eye is provided on the top of the pump and tubing for use of a cable when preferred. The connection eye is threaded into the top plate of the pump and can easily be removed or reinstalled as desired. The push-in fittings on the SamplePro pump are designed to provide at least 25 lbs. combined pullout strength when used with QED tubing. QED is not responsible for loss of the pump if non-QED tubing is used.

Description

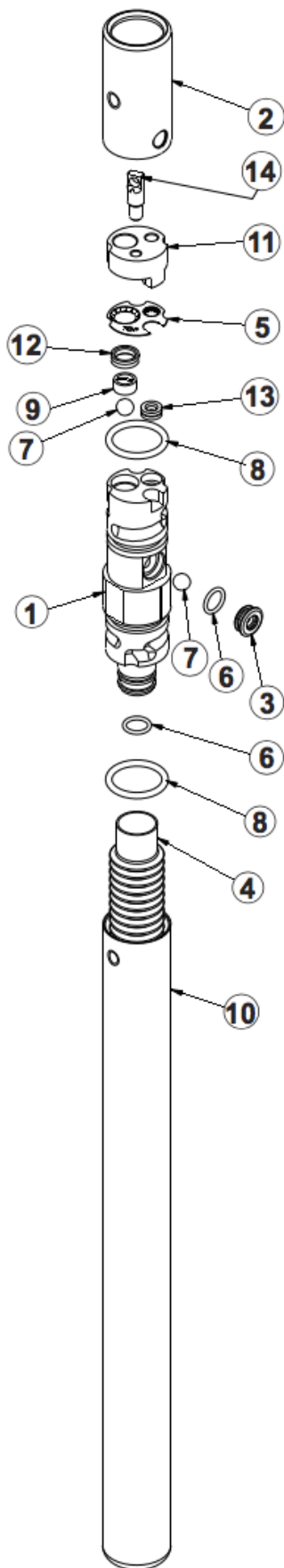

Item No.	QTY	Part No.	Description
1	1	38437EP	Head
2	1	38434EP	Cover
3	1	38439EP	Inlet
4	1	38424	Bladder PE
5	1	38436	Grab Plate 1/4" Tube x 1/8" Tube
6	3	38470	O-Ring, Viton
7	2	38471	Ball, Teflon
8	2	35172	O-Ring, Viton
9	1	38438EP	Ball Stop
10	1	38440EP	Body
11	1	38435	Plate 1/4" Tube x 1/8" Tube
12	1	38677	Seal Discharge
13	1	38676	Seal Air Supply
14	1	38833	3/4 Sample Pro Eye Bolt

Assembly

Use **Figure 2**, (Page 3) to identify main pump components and **Figure 3**, (below) to identify O-ring locations. Detailed exploded view drawing of the upper end of the pump are shown on pages 7 and 8.

1. See **Figure 3** (below) to identify locations where O-rings and seals are to be installed and install all O-rings and seals.
2. Connect the bladder to the pump head. The PE bladder pushes onto the pump head barb until the bladder fully covers the barb.
3. Attach the pump head to the body by engaging the bayonet dimples into the grooves and twisting them together until the engagement snap is felt and head and body alignment marks line up.
4. With the pump on its side, insert the inlet check ball (same as the discharge check ball) into the side of the pump head, then press in the inlet valve seat by pushing with your thumb. Pre-wetting the parts with distilled water is recommended to aid assembly
5. With the pump vertical, insert the discharge check ball into the top of the pump head, place the discharge ball stop into place above the check ball, using the supplied needle nose pliers, see **Figure 5**, (Page 6).
6. For the push-in tubing fittings, place the thin metal lock disk in the "TOP" up position on the top of the pump head, with the lock disk edge slots lined up with the posts on the pump head. Then place the thick, upper plate on top of the lock disk, again with the slots and posts lined up. Finally, twist the pump cap onto the pump head until the engagement snap is felt and the hole in the side of the pump cap lines with the inlet port. Cover and body alignment marks will line up.

Figure 3

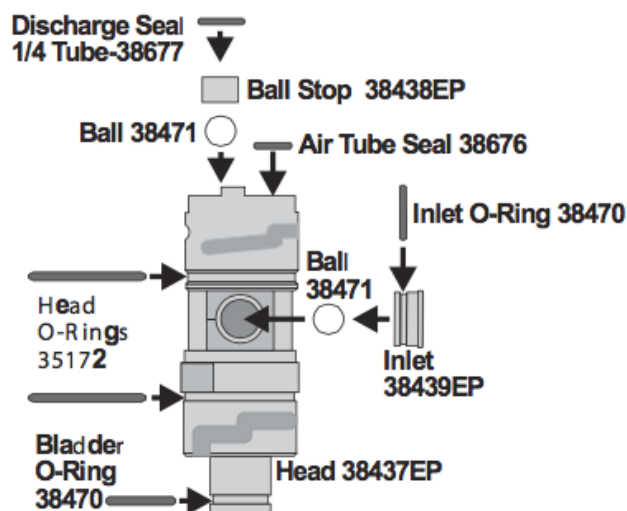

Assembly/Disassembly

Attaching Tubing

A tubing insertion tool is provided to make the small-diameter tubing used on this pump easier to grip and push into the pump. The tool is shown in **Figure 4**.

1. Cut both tubes to equal length; cutting the tubes at a slight angle will make insertion easier.
2. Grip the 1/4" tube ONLY in the large groove in the insertion tool, leaving 3/4-1" of tubing extending from the end of the gripping jaw.
3. Hold the insertion tool at the jaw end of the tool, FORWARD of the tool's pivot point, squeezing the jaws together.
4. Push the 1/4" tube into the pump while rocking the tool slightly Watch and feel for the tube to push 1/4" past the point of initial resistance into the pump.
5. Pull back on the tube to check that it is inserted firmly.
6. Repeat for the 1/8" air tube.

Figure 4

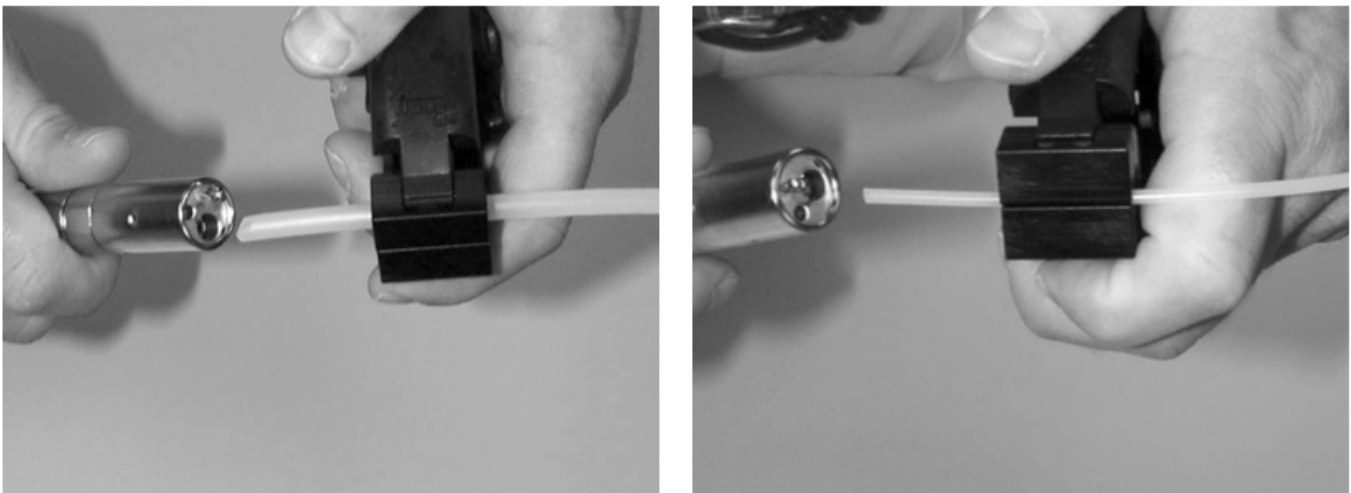

Disassembly

Use **Figure 2**, (Page 3) to identify main pump components and **Figure 3**, (Page 4) to identify O-ring locations.

1. Reverse assembly sequence, taking care to position pump to retain check balls during removal of valve seats and stops. A screwdriver can be used if necessary to remove the inlet valve seat.
2. Pull the PE bladder off of the pump head barb by pulling firmly, then discard.

Cleaning / Decontamination Note

If it is desired to operate the pump outside the well, such as in a pail for decontamination purposes, the operating pressure of the pump should be reduced to 35 PSI or less to avoid rupturing the bladder

Using the Supplied Needlenose Pliers for Assembly/Disassembly

Needlenose pliers are provided to make handling of certain smaller parts easier to handle during cleaning assembly and disassembly. **Figure 5** demonstrates placement of the check ball stop into the pump head.

Figure 5



Figure 6

Figure 6

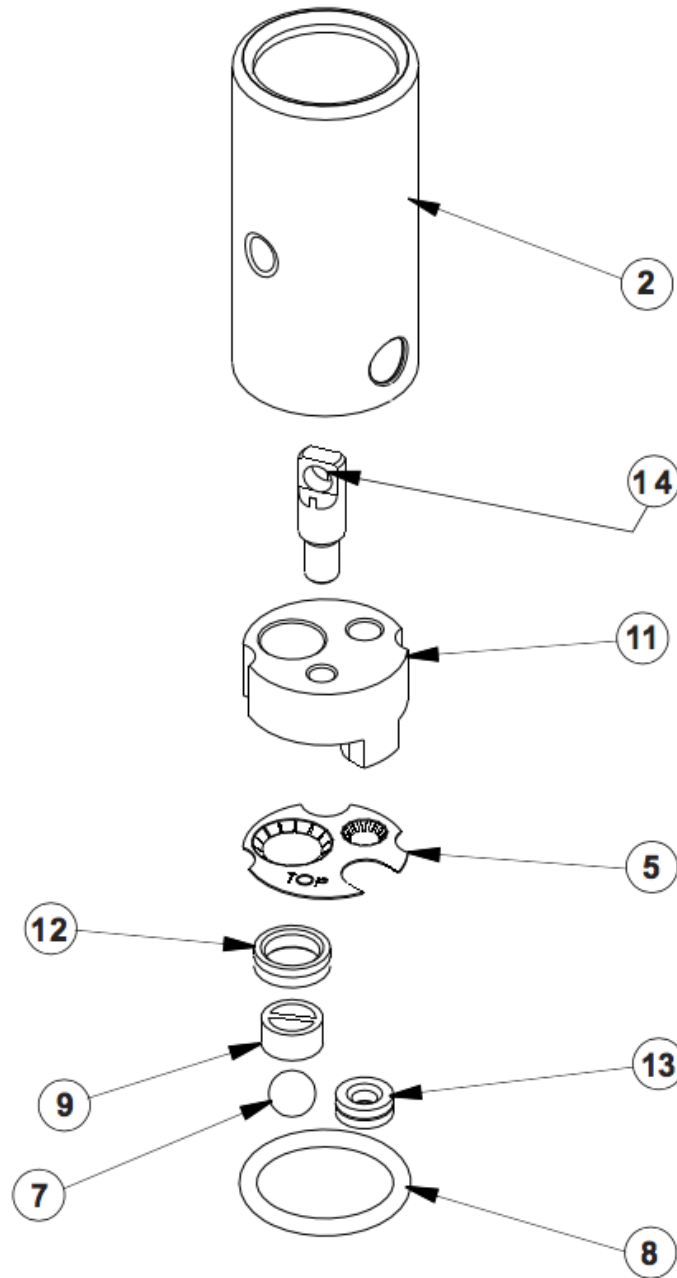

Item No.	QTY	Part No.	Description
2	1	38434EP	Cover
5	1	38436	Grab Plate 1/4" Tube x 1/8" Tube
7	1	38471	Ball, Teflon
8	1	35172	O-Ring, Viton
9	1	38438EP	Ball Stop
11	1	38435	Plate
12	1	38677	Seal Discharge
13	1	38676	Seal Air Supply
14	1	38833	3/4 Sample Pro Eye Bolt

Figure 7

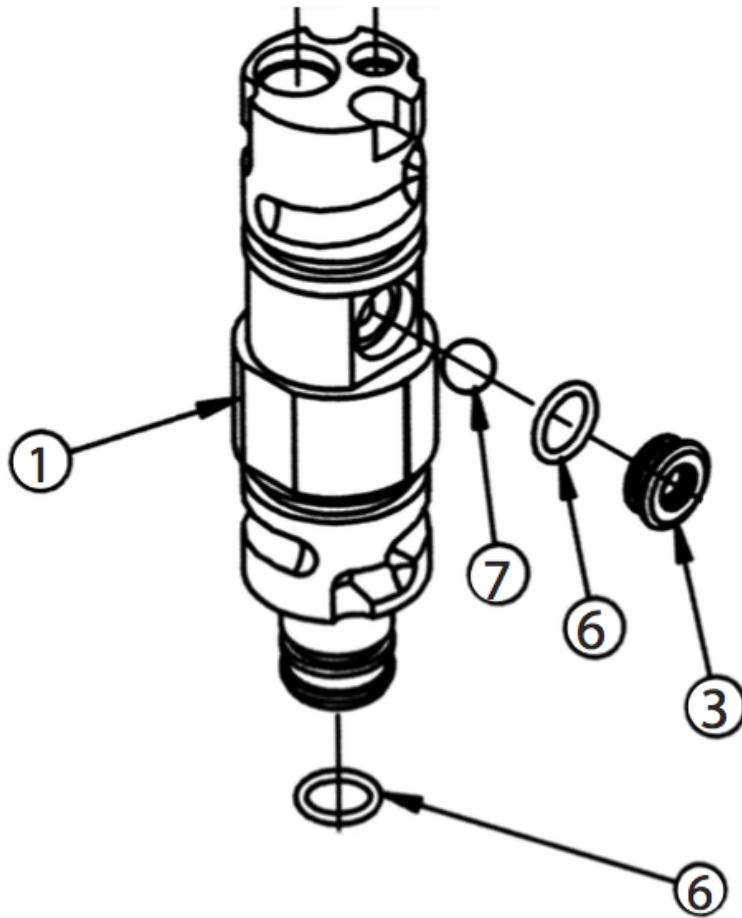

Item No.	QTY	Part No.	Description
1	1	38437EP	Head
3	1	38439EP	Inlet
6	2	38470	O-Ring, Viton
7	1	38471	Ball, Teflon

Bladder Replacement

1. Pull bladder down to remove it from the pump head.
2. Inspect the condition of the barb o-ring and replace it if necessary. Failure of this o-ring could cause the water sample to be contaminated by pump drive air.
3. Install the new bladder by pushing it onto the pump head barb until the bladder fully covers the barb, making sure the barb o-ring does not roll out of its groove.

NOTE: For reasons of contamination and leak integrity, these bladders are designed for one-time use only. QED cannot be held responsible for cross contamination or leakage failures if bladders are reused.

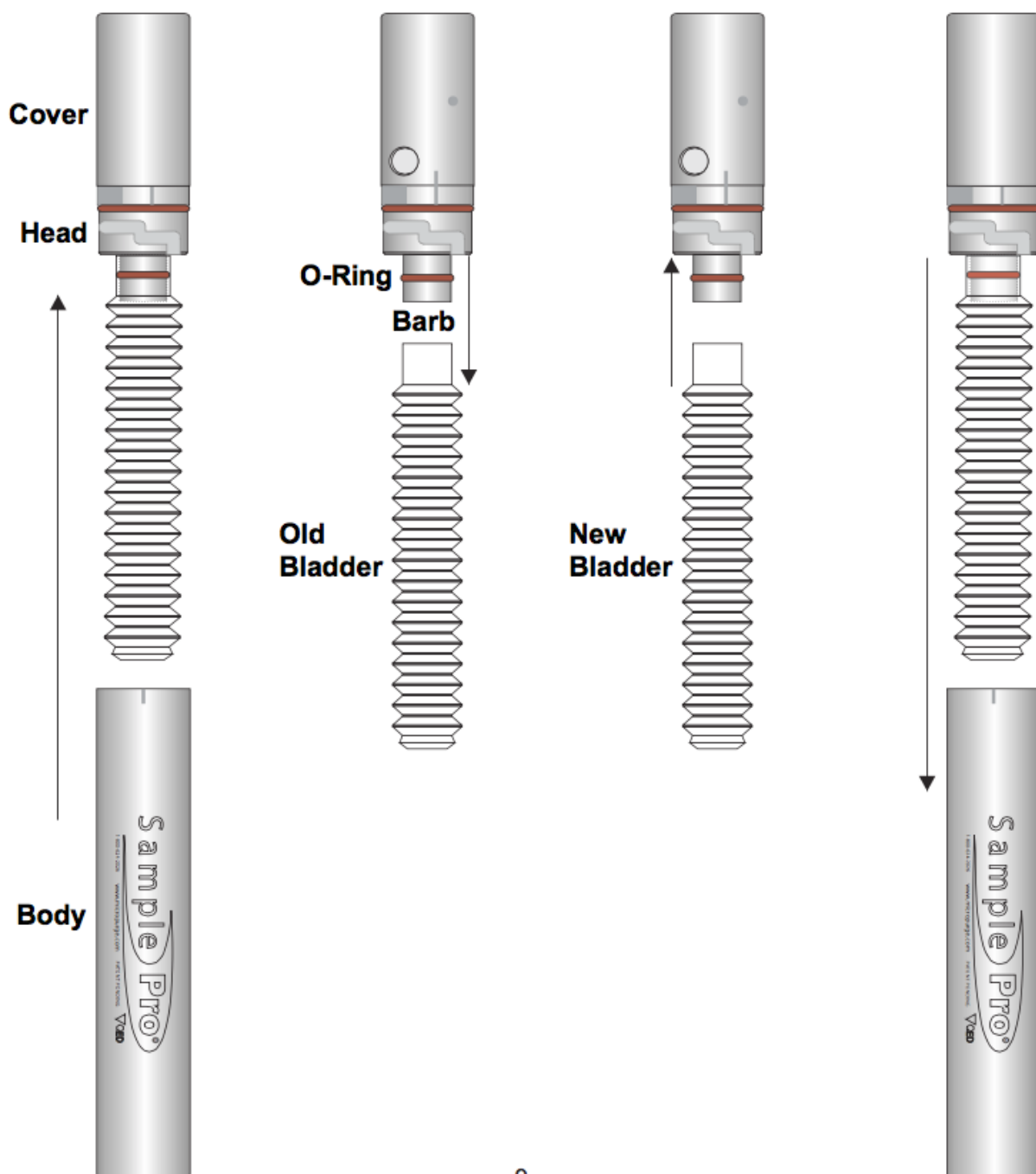

Specifications

Materials:

Body-303 stainless steel

Inlet & Discharge Housing - 303 Stainless Steel

Bladder - Polyethylene

O-rings - Viton

Fittings:

Push-inType

Air - 1/8" (3.2 mm) O.D.

Discharge - 1/4" (6.4 mm) O.D., 3/16" (4.7 mm) I.D.

Maximum Lift: 200 Feet (61 m)

Pump Volume: .33 Ounces (10 Milliliters)

For additional assistance contact QED Service at:

Phone:1-800-624-2026 1-734-995-2547

Fax:1-734-995-1170

E-mail:service@qedenv.com

24-Hour Service Hot Line:1-800-272-9559

IMPORTANT WARRANTY NOTE

The push-in and compression fittings and tubing on the SamplePro pump are designed to provide at least 25 lbs. combined pullout strength when used with QED tubing. QED is not responsible for loss of the pump if non-QED tubing is used. Re-use of the lock plate or old tube end and/or use of other brands of tubing may significantly reduce pull-out strength and cause loss of pump in the well.

Warranty

QED ENVIRONMENTAL SYSTEMS, INC. ("Q.E.D.") warrants to the original purchaser of its products that, subject to the limitations and conditions provided below, the products, materials and/or workmanship shall reasonably conform to descriptions of the products and shall be free of defects in materials and workmanship. Any failure of the products to conform to this warranty will be remedied by Q.E.D. in the manner provided herein.

This warranty shall be limited to the duration and the conditions set forth below. All warranty durations are calculated from the original date of purchase.

- 1. Dedicated-Use Systems Products-** 10 year warranty on dedicated bladder pumps equipped with Q.E.D. inlet screens, and purge pumps used in periodic, non continuous ground water sampling (up to 52 sampling events per year. All other components, equipment and accessories are warranted for one year.)
- 2. Portable-Use Systems-** Pumps, Controllers and water level meters are warranted for one year. Hose reels and Caps are warranted for ninety (90) days. Tubing and Purge Mizers are covered by a ninety (90) day material and workmanship warranty. There will be no warranty for application on tubing and Purge Mizers when used as part of a Portable System.
- 3. Separately sold parts and Spare Parts Kits-** Separately sold parts and spare parts kits are warranted for ninety (90) days. Repairs performed by Q.E.D. are warranted for ninety (90) days from date of repair or for the full term of the original warranty, whichever is longer.

Buyers' exclusive remedy for breach of said warranty shall be as follows: if, and only if, Q.E.D. is notified in writing within applicable warranty period of the existence of any such defect in the said products, and Q.E.D. upon examination of any such defects, shall find the same to be within the term of and covered by the warranty running from Q.E.D. to Buyer. Q.E.D. will, at its option, as soon as reasonably possible, replace or repair any such product, without charge to Buyer. If Q.E.D. for any reason, cannot repair a product covered hereby within four (4) weeks after receipt of the original Purchaser's/Buyer's notification of a warranty claim, then Q.E.D.'s sole responsibility shall be, at its option, either to replace the defective product with a comparable new unit at no charge to the Buyer, or to refund the full purchase price. In no event shall such allegedly defective products be returned to Q.E.D. without its consent, and Q.E.D.'s obligations of repair, replacement or refund are conditioned upon the Buyer's return of the defective product to Q.E.D.

IN NO EVENT SHALL Q.E.D. ENVIRONMENTAL SYSTEMS, INC. BE LIABLE FOR CONSEQUENTIAL OR INCIDENTAL DAMAGES FOR BREACH OF SAID WARRANTY.

The foregoing warranty does not apply to major sub-assemblies and other equipment, accessories and parts manufactured by others, and such other parts, accessories, and equipment are subject only to the warranties, if any, supplied by the respective manufacturers. Q.E.D. makes no warranty concerning products or accessories not manufactured by Q.E.D. In the event of failure of any such product accessory, Q.E.D. will give reasonable assistance to the Buyer in obtaining from the respective manufacturer whatever adjustment is reasonable in light of the manufacturer's own warranty.

THE FOREGOING WARRANTY IS IN LIEU OF ALL OTHER WARRANTIES, EXPRESSED, IMPLIED OR STATUTORY (INCLUDING BUT NOT LIMITED TO THE WARRANTIES OF MERCHANTABILITY AND FITNESS FOR A PARTICULAR PURPOSE), WHICH OTHER WARRANTIES ARE EXPRESSLY EXCLUDED HEREBY and of any other obligations or liabilities on the part of Q.E.D., neither assumes nor authorizes any person to assume for it any other obligation or liability in connection with said products, materials and/or workmanship.

It is understood and agreed that Q.E.D. shall in no event be liable for incidental or consequential damages resulting from its breach of any of the terms of this agreement, nor for special damages, nor for improper selection of any product described or referred to for a particular application.

This warranty will be void in the event of unauthorized disassembly of component assemblies. Defects in any equipment that result from abuse, operation in any manner outside the recommended procedures, use and applications other than for intended use, or exposure to chemical or physical environment beyond the designated limits of materials and construction will also void this warranty. Q.E.D. shall be released from all obligations under all warranties if any product covered hereby is repaired or modified by persons other than Q.E.D.'s service personnel unless such repair by others is made with the written consent of Q.E.D.

If any product covered hereby is actually defective within the terms of this warranty Purchaser must contact Q.E.D. for determination of warranty coverage. If the return of a component is determined to be necessary, Q.E.D. will authorize the return of the component, at owner's expense. If the product proves not to be defective within the terms of this warranty, then all costs and expenses in connection with the processing of the Purchaser's claim and all costs for repair, parts and labor as authorized by owner hereunder shall be borne by the purchaser.

RESPONSIBILITY OF THE PURCHASER

The original Purchaser's sole responsibility in the instance of a warranty claim shall be to notify Q.E.D. of the defect, malfunction, or other manner in which the terms of this warranty are believed to be violated. You may secure performance of obligations hereunder by contacting the Customer Service Department of Q.E.D. and:

1. Identifying the product involved (by model or serial number or other sufficient description that will allow Q.E.D. to determine which product is defective).
2. Specifying where, when, and from whom the product was purchased.
3. Describing the nature of the defect or malfunction covered by this warranty
4. Sending the malfunctioning component, after authorization by Q.E.D. to:

QED Environmental Systems, Inc.
2355 Bishop Circle West
Dexter, Michigan 48130

